

Exterior Dentil Corners

Installation Instructions

Contents of Endcap Pack:

- 1 Endcap (Left)
- 1 Endcap (Right)
- 4 Rivets

Contents of Inside/Outside Corner Pack:

- 1 Inside Corner
- 1 Outside Corner
- 8 Rivets

Contents of Outside Corner Pack:

- 2 Outside Corners
- 8 Rivets

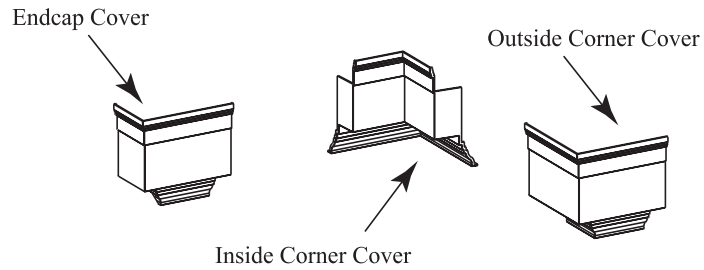

-The Exterior Dentil Corners are sold to complete the installation of the Exterior Dentil. There are three styles of corners available.

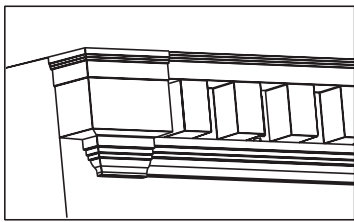

Endcap

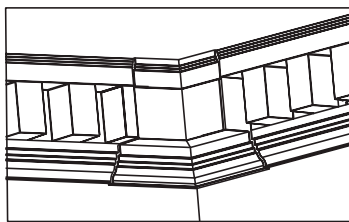

Inside Corner

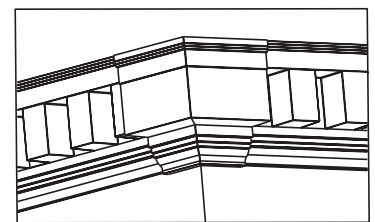

Outside Corner

Note: The Exterior Dentil shown in the illustrations are sold separately.

Attach the Endcaps, Inside Corners, and Outside Corners to the Exterior Dentil with the included rivets (use 1/8" drill bit). The covers may also be attached using painted screws (not included). When fastening the bottom surface of the covers to the Exterior Dentil it's necessary that the rivets enter a tooth. The illustrations below show the placement of rivets on the three different covers.

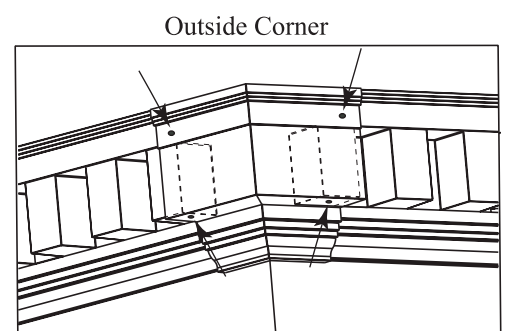
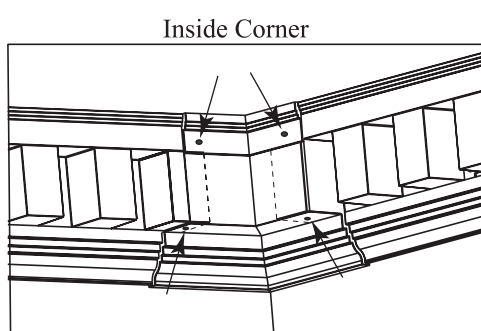
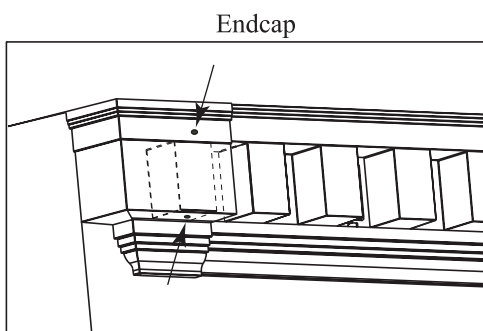

When installing the covers there may be interference between the cover and the dentil tooth. If this occurs remove the wall on the cover as shown in Figure 1B by scoring from the back side with a knife.

Note: An Inside Corner Cover is shown in Figures 1A and 1B as an example. The wall on the Outside Corner Cover and the Endcap Cover may need to be removed also.

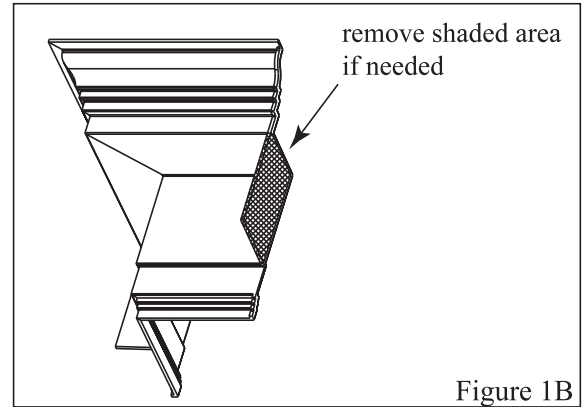
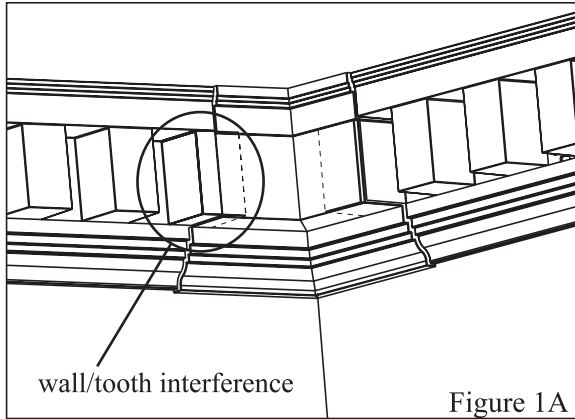

Optional: If needed, Endcaps can be created by cutting Outside Corners at the scribe lines. See Figure 2 below.

